









Self-contained ice maker - Sprayer system Daily production up to 150 lbs

Hotel	████████████████████
Restaurant	██████████████████
Fast food	██████████████
Bar	████████████████████
Disco	████████████████████
Fish market	██████████████
Supermarket	██████████████
Medical & SPA	██████████████
Industry	██████████████

► Position n°



► Features & Plus

- Compact and crystal cube
- AISI 304 SS Scotch Brite finish 
- Tropical class +43°C 
- Removable and cleanable air filter
- Air cooling system
- Easy cleanable internal rounded surfaces 
- HCFC-Free insulated storage 
- RoHS Free 
- Disappearing insulated door
- Electromechanical operation 
- ON-OFF rocker switch 



AISI 304 SS Scotch Brite finish



Adjustable Stainless Steel feet



Easy cleanable internal rounded surfaces



Disappearing insulated door

► Available ice cube size



► Prod. 24h

	Air temp.	Water temp.	lbs
	50° F	50° F	150
	70° F	60° F	145
	90° F	70° F	120

2 Years Warranty
subject to limitations

► Certifications available for this model



Energy Verified
Rendement
Énergétique Vérifié





Ice Cube

CB 674A 2018



Self-contained ice maker - Sprayer system Daily production up to 150 lbs

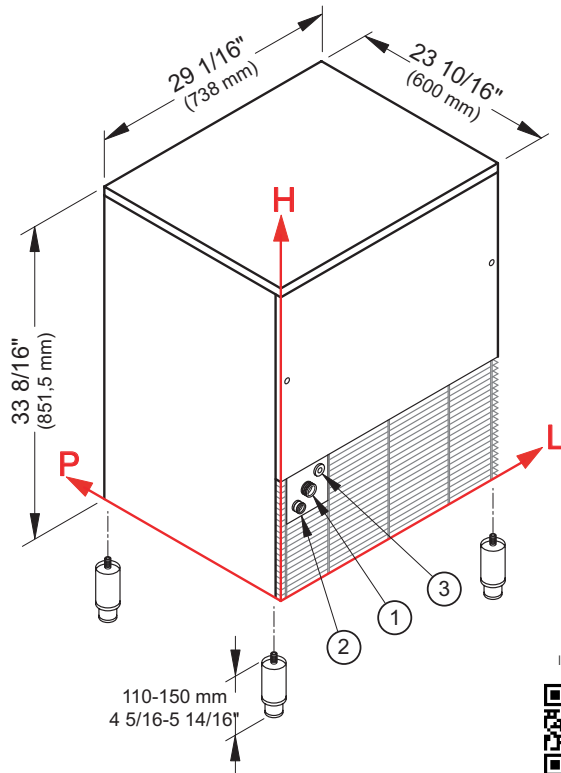

Installation



► Working conditions

- Location: **Indoor**

	Min	Max
Ambient temperature	+50° F	+110° F
Water temperature	+37° F	+90° F
Voltage	-10%	+10%
Water inlet pressure	1bar (14 psi)	6bar (84 psi)

► Connections

All measures are referred to the rear bottom-left corner (L-H-Ø)

- ① Water in.: 4 9/16" - 8 11/16" - 3/4"
- ② Water out.: 2 2/16" - 7 1/16" - 15/16"
- ③ Electrical connections: 6 5/16" - 10 1/16"



Production in 24h	120 lbs	Fuse	10 A
Store capacity, up to	88 lbs	Water consumption	35 gal/100 lbs
Cooling system	A	Sizes (L-P-H in)	29 1/16 - 23 10/16 - 33 8/16
Kind of cube	A-18g	Sizes with pack (L-P-H in)	30 11/16 - 25 3/16 - 39 15/16
Refrigerant	R404A	Net weight	159 lbs
Standard voltage	115 V ~ 60 Hz	Gross weight	185 lbs
Average power consumption	450 W	Finish	AISI 304 stainless steel, scotch brite

All the technical information must be considered at the following conditions:
 Sizes without feet
 Standard Cube (18 g)
 Production at Ambient temperature +90° F / Water temperature +70° F
 Water consumption at Ambient temperature +90° F / Water temperature +70° F
 Average power consumption at +109° F

Models and specifications are subject to change without notice

Rev. 02 - Issued May 2018



www.bremaice.it
info@bremaice.it

Bim + Data download

